

EM-243-SPF POSITIONING DRIVER 12-24V 50A

FEATURES

- quadrature pulse counting
- multiple dynamic settings
- solid state power stage
- one or two pulse feedback
- voltage or mA control
- position accuracy max. 0.2%
- versatile setting options
- brake output
- digitally settable parameters
- housing options available
- motors up to 500W
- EMC measured product



EM-243-SPF is a positioning driver to be used with DC-motors. The solid state power stage operates with high efficiency and as realized with FET-transistors. Its literally everlasting compared to relay solutions. Feedback is done with one or two line pulse signal. Although position feedback can be done with one pulse line it is always preferred and more secure to do it with two 0°/90° pulse lines. This driver includes an analog control with three signal ranges, 0-5,5V, 0-11V or 4-20mA. Input is freely scalable inside the range. The max. electrical accuracy of the driver and feedback is 0.2% which is adequate for most actuator positioning applications.

The settings and adjustments are done with parameters as in all new generation Electromen products. Included in the parameters is also the learn routine which will help to determine the full movement range fast and easily. Additively the movement range can be modified from both ends with SW-limit parameters. Possible cumulating pulse count errors can be avoided with manually or automatically triggerable home drive. Current limits and driving speeds can be set individually for both directions. Driver includes also many other dynamic adjustment features like parameter for load compensation, dead-zone setting (positioning window), start and stop ramps for smooth direction change and braking zone for well operating positioning.

The parameter setting and status monitoring is done with EM-236A Interface Unit. With EM-236A the right parameters can also be copied easily to other driver units. The on-board LED-light indicates the possible fault situations with blinking codes. If needed, the fault alarm can be also given out through combiport. This port can be set as "position OK." output or it can work as an analog position signal output. Additively it can work also as disable input. Device is EMC tested for industrial and household environment and operating temperature range is quite wide. There are also same housing options available for EM-243-SPF driver card as for the standard EM-243.

TECHNICAL DATA EM-243-SPF prog. v1.8

Supply voltage	12-48V (10-58V)
Shut down voltage	8V
Power up voltage	9V
Motor current cont.	40A, mom. 60A (Ta<50°C, 2kHz)
Motor current cont.	25A, mom. 40A (Ta<50°C, 16kHz)
Current limit	1-100A (in start max. 150A 1s)
Overtemp. limit	100°C
Fan out activation	50°C
PWM frequency	16kHz /2kHz
Pulse sampling rate	0.2ms
Input freq. of pulse lines max	700Hz
Control input ranges (position)	0-5,5V / 0-11V / 4-20mA
Positioning potentiometer	10k recom. 22k max.
Input resistor for mA-signal	250ohm (socket on board)
Position out. signal range	0-5V or 0.5 - 4.5V, 0V for FAULT
Digital input levels	high =4-30V, low=0-1V
Digital input impedances	typ. 47kohm
Limit-FW / -BW and pulse inputs	imp. typ 10kohm
Combiport	
- Fault output, NPN, open coll.	max 30V / 1A
- Disable -in <input type="checkbox"/>	Uin < 1V (NPN)
- Indication out impedance <input type="checkbox"/>	1kohm
Fan-output NPN open coll.	max. 40V /1A
Brake output NPN open coll.	max. 60V / 5A
Connectors for motor and supply	max. 2.5mm ² cable
Connectors for signals	max. 1mm ² cable
Operating temp(Ta)	-40...60°C
Dimensions	107x72x40mm
Weight	190g
EMC-tested for household and industrial environment (EMC)	EN-55022B, EN-61000-4-3, -4, -5, -6 passed

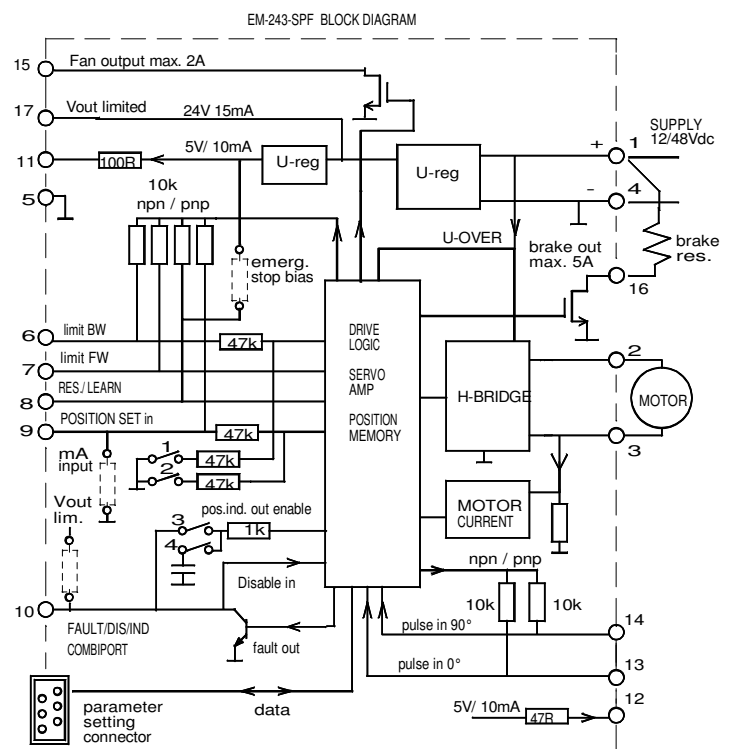

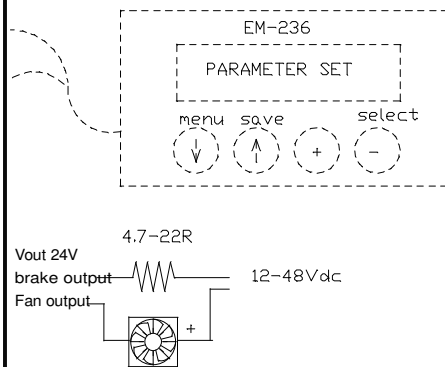
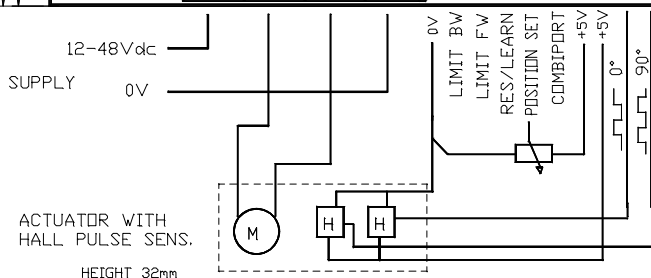
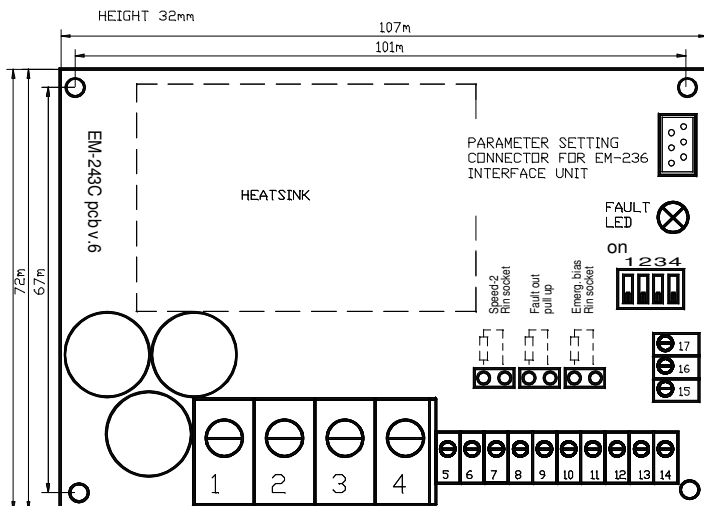

CONNECTION ADVICE

Supply voltage should be nominally 12-48Vdc. max. 58Vdc

Ripple should be lower than 30% even with maximum load.

NOTICES!

1. Wrong supply polarity can damage the device.
2. There is no inbuilt fuse in this device. So use an additive outside fuse and choose it according to your application.
3. The meaning of the terminals can change when changing the parameters (pls.see the parameter list and explanations).

TAKING IN TO USE

The setting of the controller is done with parameters, and the parameters can be set and adjusted with EM-236 Interface Unit. Making changes is easy and precise. Copying the parameters to multiple units is simple and accurate. The same parameters that are saved to one unit can be copied to another unit with one push of a button. After the two first parameters have been set according to the application, the actuator and control wires can be connected and the operation can be adjusted with the remaining parameters.

POSITION FEEDBACK

Select 1 or 2 pulselines with parameter 1 according to your application. The position information has more risk to be corrupted when controller is used with one pulse line, as the signal does not have information about the direction of the movement. For example few pulses are more easily counted to wrong direction during fast direction change with difficult loads. So it is recommended to use two pulse lines (0° and 90°) whenever available.

FULL RANGE

Full range is the full mechanical movement of the linear motor or positioning system. At first it is always necessary to determine the full range before it is possible to drive the system. When the full range is determined it is also set to correspond the selected and set control range that can be for example 0-5V. Position feedback is received as pulses, and full range is determined as the number of pulse edges received during the full movement from start to end. If this number is known it can be set as the value of parameter 25 (Full range).

HOME RUN (position counter reset)

The position feedback is received as pulses so the driver can not know the right position before its pulse counter is reset in some known position. Home run command will drive the motor to selected end of the full range and there it will reset the pulse edge counter. Before the positioning can be used the home run must be completed. After home run the position is saved to the driver's memory and will be valid even after the power is cut off and restored. Home run is configured with parameter 14, values 1 or 2.

LEARN ROUTINE

Learning is a special option for finding the full range and taking the system in use without knowing the number of pulses for full range. Learn routine is selected with par.14 val.7. and started with 5s command to RES/LEARN input. Learn routine will drive the motor forward (FW) until it reaches the outer end then it starts the motor backwards (BW) and drives to inner end. During this routine the driver "learns" the number of pulse edges for full range and also retrieves the absolute position by resetting the counter in the inner end. After learn routine is done the driver can be used for positioning and par 14 should be set to some suitable value for normal use of the application. Notice: Learn routine is ran to the hard end (or to the limit switches if wired). Notice: To see the learned and right number of the full range pulse edges, you have to download (OK to Load&Edit) the parameters from driver with EM-236 Interface Unit once again. Or if you are viewing the par.25 while learn routine you can try to change the value and the EM-236 Interface unit will first display the learned range. After this its possible to edit this reading.

AUTO HOME

Auto home is an automated home run that is triggered during normal operation whenever the motor is run to the FW or BW end switch or close to the software end limit (SW-limit). Well configured auto home can effectively prevent cumulating position error. Its especially useful when working with only one feedback pulse line. Auto home configures with par. 14 (values 3,4,5 or 6). Notice: The auto-home will be ran to the hard end (or to the limit switches if wired). If you choose the auto-home to be triggered from limit switch inputs or SW-limits, the option of using the 5seconds command to RES/LEARN input is also available.

RANGE SETTING OF POSITION SET INPUT (also DIP SWITC 2)

Options for max. ranges are 0 to 5,5V, and 4 to 20mA if you place a 250ohm resistor to the resistor socket on the driver board. Using 0 to 11V range requires you to set the DIP switch 2 to "ON" position. Your individual control scale can be set with parameters 21 and 22 as Volts or you can let the driver to measure your min. and max. control values. If you choose to set the min. and max. as Volts, pls. notice that the values are in ratio to the lowest range 0-5,50V, and with 0-11V range you have to divide the actual voltage with two. With current signal the right value is 1×250 . Eg: 4-20mA = 1,0 - 5,0V. Most accurate way is to let the driver to measure the values. So first connect and adjust minimum value to set input (pin.12) and change the par.21 to val. 551, after value stops blinking the display shows the measured value. Then adjust the maximum control value to pin.12, and change par.22 to 551. After a while the measured value will be displayed. Always remember to save with a long push to save button, before disconnecting EM-236 and taking power off from the driver. Notice: If control min. value is set higher than max. value the movement range will be inverted and set accordingly.

POSITIONING DYNAMICS

Dead zone (par.17) is to determine the accuracy of positioning. This parameter has a major effect to positioning accuracy. The smaller it is determined the more accurately the positioning is done. Notice: If it is set too small compared to accuracy level of the mechanics an oscillation or unstability in positioning will occur.

Braking zone (par. 18) is used to optimize the time needed for positioning. Too high value slows down too early, and too low value will cause an fast position passing and needs a corrective return driving.

Load compensation (par.11) when set to right value, will ensure the needed force to start driving and to taking the load into the right position. With a high load and too low load compensation value, the motor doesn't have enough force to reach the right position. Start testing with zero value and increase value until motor behaves unstably and starts twitching. Thumb rule in this point is to decrease the value with 25%.

Current limits should be set according to the motor nominal max. current or according to the required current of the application (if lower than nom).

Start and stop ramp (par. 19 & 20) are to smoothen the direction change. Often suitable value for stop ramp is at the halfway point of the start ramp. A too long stop ramp can make the direction change too time consuming and a too short stop ramp can cause mechanical stress.

Fault situations are indicated with coded blinking of the red LED. Fault alarm can be forwarded out through combiport (pin.13). Fault situation is reset with a short (<5s) command to RES/LEARN input . Some faults are reset automatically with a new position command to opposite direction. Instead of fault indication the combiport can be set to indicate the status of the positioning as an "on position" output, or it can be set to give an analog position information with 0-5V or 0.5-4.5V signal. Configuration of the combiport is done with par.9. Notice: If it is set to give analog information out (par.9 val3/4), also the DIP-switch 3 should be set to ON position.

If Combiport is selected to be fault output, it will also work as disable input when externally pulled down. If this terminal is selected to be used for indication the "disable in" function can be set and transferred to work through limit input terminal pin 9 or pin 10 (par.15).

ADJUSTMENT AND SETTING

Parameter setting is done with EM-236A or EM-328 Interface Unit, which is connected by the red connector. The connected driver must be powered. During the start up routine the Interface Unit will display information about itself and then the name and program version of the target device. Then it will remain on displaying EDIT & LOAD. Pushing the "yes" button will upload and show the parameter list of the controller. Now the user can scroll the parameters with arrows, and make value changes with + and - buttons. Edited value is effective after few seconds when the value stops blinking. But notice, that the change will not be saved until you give a long push (>2s) to the "save" button. This will save the values to the EM-236s memory also. Now it is easy to copy the same values to an other driver. Just connect the unit to a powered driver and after the start up routine just press a long "save". You can repeat this until all needed units have been configured.

LIST OF PARAMETERS prog. v1.8 (defaults in parentheses)

- 1 Feed-back mode : one-pulse=1, dual-pulse=2 (1)
- 2 Limit and pulse input logic (1)
 - 1= limit inputs PNP / pulse inputs PNP
 - 2= limit inputs PNP / pulse inputs NPN
 - 3= limit inputs PNP inverted / pulse inputs PNP
 - 4= limit inputs PNP inverted / pulse inputs NPN
- 3 Speed FW: 20-100% / 0-100 (100)
- 4 Speed BW: 20-100% / 0-100 (100)
- 5 Speed HOME/LEARN: 20-100% / 20-100 (60)
- 6 Current limit out, FW: 1-100A / 1-100 (30)
- 7 Current limit in, BW: 1-100A / 1-100 (30)
- 8 Current trip delay: 0-255ms / 0-255 (100)

(0 = tripp not in use)
- 9 Combiport (pin 13) function: 1-4 (1)
 - 1= used as Fault out / Disable in (fault/dis=0V)
 - 2= gives the "on position" data (on pos=0V)
 - 3= gives position info out with 0-5V
 - 4= gives position info with 0.5-4.5V and fault =0V
- 10 Over voltage limit: 15-60V / 15-60 (55)
- 11 Load compensation: 0-255 / 0-255 (0)
- 12 Time out: 1-255s. / 1-255 (0= not in use) (0)
- 13 Hour and start counter reset (0)

set value = 1 and press SAVE -> hour and start counter reset
- 14 Home run / learn function: 1-7 (1)
 - 1= Home run with RES / LEARN input to BW direction (>5s. comm.)
 - 2= Home run with RES / LEARN input to FW direction (>5s. comm.)
 - 3= Auto-Home from BW LIMIT input to BW direction (pin 9)
 - 4= Auto-Home from FW LIMIT input to FW direction (pin 10)
 - 5= Auto-Home triggered with inner soft limit to BW direction
 - 6= Auto-Home triggered with outer soft limit to FW direction
 - 7= Learn routine with >5s command to RES /LEARN input (pin.11)
- 15 Disable input configuration (0)

0= Disable only to pin.13, 1=disable to pin.10, 2=disable to pin.9
- 16 Not in use
- 17 Dead zone : 0,2-5% / 2-50 (10)
- 18 Braking zone : 1-8% / 1-8 (3)
- 19 Start ramp : 0,1-2.5s / 0-25 (10)
- 20 Stop ramp : 0,1-2.5s / 0-25 (3)
- 21 Set value min: 0...5.50V / 0-551 (0)
- 22 Set value max: 0...5.50V / 0-551 (550)

For parameters 21 and 22 value 551 will do an auto setting
- 23 Inner (BW) SW-limit: 0...+50% / 0-500 (5)
- 24 Outer (FW) SW-limit: 0...-50% / 0-500 (5)
- 25 Full range (pulse edges) 100-65535 / 100-65535 (1000)
- 26 Pwm frequency 1 = 2kHz and 2 = 16kHz
- 27 Brake output options (0)
 - 0= output activates in overvoltage situation
 - 1= output activates when run, this is for releasing magnetic brake
- 28 Serial line configuration, speed, parity, and number of stop bits (1)
 - 1 =9.6kbps 8N1 5 =19.2kbps 8N1
 - 2 =9.6kbps 8N2 6 =19.2kbps 8N2
 - 3 =9.6kbps 8E1 7 =19.2kbps 8E1
 - 4 =9.6kbps 8O1 8 =19.2kbps 8O1
- 29 Modbus address 1-247 (1)
- 30 LOCAL / BUS - input pin 6 - (0)
 - 0 = BW limit input, local /bus selection only with bus
 - 1 = Pin 6 defines control mode local/bus, pin open = LOCAL
 - 2 = Pin 6 defines control mode local/bus, pin open = BUS

- | | |
|---------------------|---------|
| 1. 1-trip | 1 blink |
| 2. pulse lost | 2 blink |
| 3. over temperature | 3 blink |
| 4. over voltage | 4 blink |
| 5. time out trip | 5 blink |
| 6. learn corrupted | 6 blink |

MONITORABLE VALUES (Can be read with EM-236)

- 1 fault code (see above) 1-6
- 2 motor current 0-20A / 0-200
- 3 target position 0-100,0% (0-1000)
- 4 realized position 0-100,0% (0-1000)
- 5 position as pulse edges 0-65535
- 6 hour counter (max.65535h)
- 7 start counter (max.65535)
- 8 start counters over flow counter (max. 65535)

ABOUT PARAMETERS

1. Feedback mode is a mandatory setting to be done according to the application. 1= for one pulse line only, 2= two pulse lines for 0° and 90° pulses.
2. Limit and pulse inputs (pins 9, 10, 2 and 3) can be set to work with positive or negative logic. Signal can be either pulling up =PNP or down to 0V which is often marked as NPN signal.
- 3 & 4 driving speed to FW (out) and BW (in) directions.
- 5 The speed setting for "home run" and "learn" routines.
- 6 & 7 Current limit setting for FW (out) and BW (in) driving directions.
- 8 Current tripp delay time 1-255ms; if set to 0 the tripp is disabled
- 9 Combiport configuration (pin 13). This terminal can work as combined input-output. It can be fault output and disable input or an on position indicator giving an "on position" signal after a succesfull positioning. It can also be used to indicate the position with continuous voltage signal 0-5V (val.3) or 0.5-4.5V + 0V fault (val.4).
Notice: With val. 3 or 4, also the DIP3 must be set to "ON" position.
- 10 Over voltage limit. Motor is switched to free wheel if the selected voltage level is exceed. This saves the driver or other devices in supply line from over voltages in case the motor generates surplus energy during slow down or braking.
This can happen eg. in vehicle or lifting applications.
- 11 Load compensation (Rxl-comp) ensures good torque with low speeds. It is good to start testing with zero value, but if the motor seems weak when starting or slowing down to the right position this value can be increased carefully and step by step.
Notice: Too high value is recognized from oscillation and/or twiching.
- 12 Time out tripp will cut off the driving if continuous driving to the same direction exceeds the set value (stated in seconds).
- 13 Usage counter reset parameter is for manual reset of counters. Choosing and saving value 1 will reset the hour and start counters.
- 14 Home run direction and start condition setting or enabling the learn routine for finding the full movement range.
Home run can allways be started with RES/LEARN input (pin 11). Auto home can be started with actual limit switch inputs or with so called SW-limits (par. 23 and 24). Last special option (value 7) is for starting the learn routine. That is an end to end drive routine to count and determine the real full movement range.
- 15 In case the pin.13 is used for indication, the limit switch inputs pin 9 or 10 can be configured to work as disable input.
- 16 Not in use in this program version.
- 17 Dead zone is for determining the suitable positioning accuracy. If this positioning window value is small the positioning is tended to be done more accurately. If value is too small compared to the accuracy of the other parts of the application, the system might not be able to work properly. Notice. Other parameters like braking zone and FW/BW speed settings will also affect to the positioning behaviour.
- 18 Braking zone value is determined as a percentage of the full movement range. It determines how early driver starts to slow down before reaching the right position. Main rule is that small value for slow applications and high value for fast applications.
- 19 & 20 Start and stop ramps are used to smoothen the speed and direction changes. Its the time from 0-100% or from 100%-0 speed.
- 21 & 22 are for determining the control signal range limits. Value can be given as Volts, 0 to 550 (0 to 5,5V), or the min. and max. values can be measured automatically by setting value to 551.
Then the card will measure the signal in the POSITION SET input. Pls. read also the chapter "Control range setting".
- 23 & 24 Inner (BW) and outer (FW) SW-limits. With these adjustable limits the movement range can be limited to suite the application.
Notice: if either of these SW-limits is used for auto-home (par.14) the motor will drive over the limit when executing the home run.
- 25 The full-range is determined by setting the known or calculated full range pulse edge count to be the parameter value. Alternatively the value can be defined by making the learn run (par.14 val.7)
Notice. The learned pulse edge number is up dated to the EM-236 Interface unit display when you make a new Load & Edit data query or try to change the value right after learn routine.
to change
- 26 Power stage PWM freq. 16kHz is quiet, 2kHz offer better efficiency
- 27 Brake output configuration parameter.
- 28 Bus freq. parity and stop bits setting
- 29 Modbus address
- 30 Local / Bus input configuration.

POSITIONING WINDOW EXAMPLE

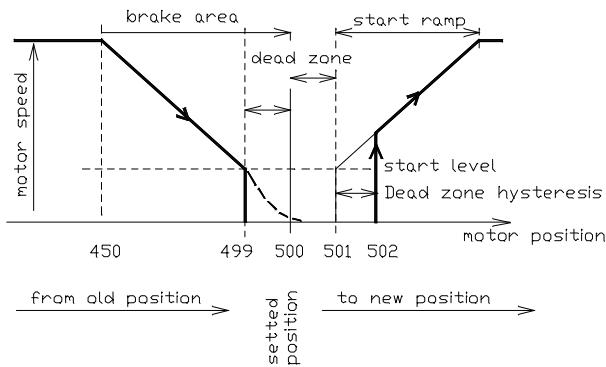

PARAMETERS SETTINGS:
 Dead zone 0.1% (= 1)
 Braking area 5% (=50)

SET position changes 0 to new position 500
 Motor run speed FW until position reach value 450. Motors starts slowing down, Until position reach value 499 and motor shut down and motor should stopped to value 500.

Motor will start again when position SET changes over 502

LEARNING CYCLE

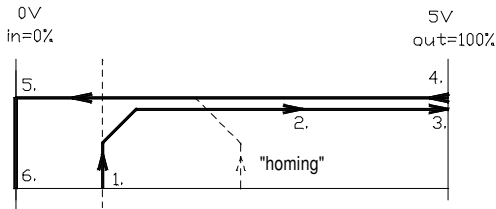

1. start learning by giving a 5s sommand to RES/LEARN (input pin 8) Notice, that parameter 14 should be set 7 to enable learn
2. motor starts to run "out" direction with learn speed
3. current limit stops the motor when mechanical end is reached
4. motor starts to "in" direction and makes a full stroke. During stroke the pulse counter measures the range.
5. motor reaches the mechanical end "in", and current limit stops the motor.
6. Device stores full range value and is ready for use
7. If you want to use RES/LEARN input after this only for "home run", then return the parameter 14 to value 1-6

RANGE SCALING EXAMPLE

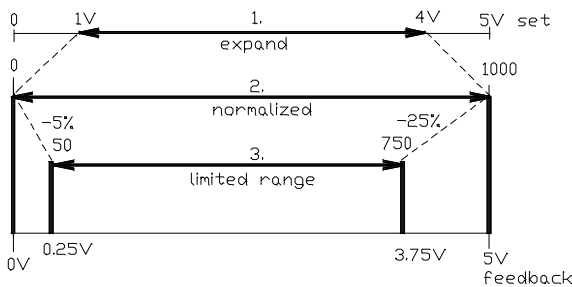

POSITION SET signal range is 1...4V
 Range is scaled with set parameters 21 = 100 and 22 = 400

Now the 1...4V signal is internally normalized to the range 0-1000.
 This normalized value corresponds 0-5V feedback range

Feedback range can be compressed with parameter 23 and 24, in this example inner limit -5% and outer -25%.

Final result is that control range 1-4V match to 0.25...3.75V feedback range

PULSE COUNTING WITH 1 or 2 PULSE LINES

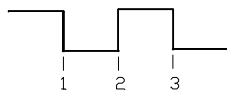

One pulse mode includes no direction information

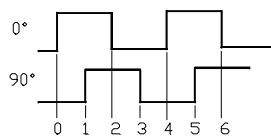

Two pulse with quadrature counting offers also the direction information