

EM-352 BRUSHLESS DC-MOTOR DRIVER 12-35V 8A

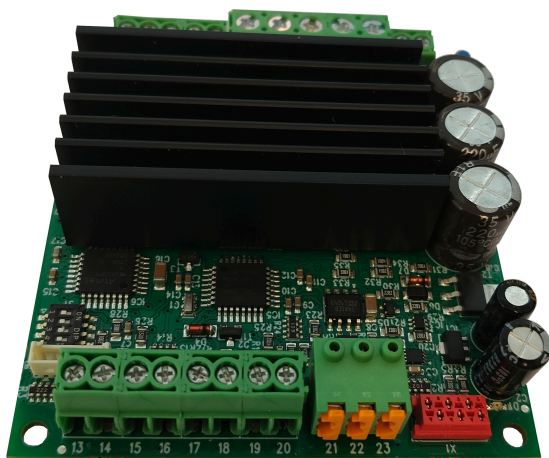

FEATURES

- Only for motor with Hall sensors
- Speed and torque adjustment
- Open/closed loop modes
- Regenerative braking option
- Braking resistor output
- Fan control output
- For motors up to 80W@12V 125W@24V
- Current limit and trip
- Indication output option
- Good efficiency
- Low EMC emissions
- DIN-rail mountable

- Firmware v1.0 or later
- Rs-485 Modbus control option
- Firmware v1.7 or later
- Added input functions, par. 11,13, 20
 - Added power on mode, parameter 15
- Firmware v1.8
- par 20 added "inverted disable" option
 - closed loop start up improved

GENERAL

EM-352 is brushless DC-motor driver with hall sensor feedback. The unit has a mosfet power stage with good efficiency and it meets also today's EMC requirements. The driver can be used with 120° commutation. This driver has true 4Q power stage, and it makes possible to use regenerative braking. In this braking method the supply voltage rises, this voltage rising can be controlled with braking resistor. If uses battery supply then the braking energy can be leaded back to battery and braking resistor will not be needed. The unit has the basic digital command inputs like direction, start/stop, disable, speed-2 activation and there is analog inputs for speed and current control. EM-352 has PNP output for fault indication use. Several input and output functions can be modified with parameters. Driver includes overvoltage, undervoltage and overtemperature protections. These fault situations are indicated with fault on-board LED. Current limit situations can be reset with reset input, reset-timer or by setting analog speed control to value to 0.

There are two control options for speed. Direct control (open loop) sets motor voltage in proportion to control voltage as with a standard DC-motor. Closed loop uses hall sensor feedback for speed control, this mode offers good speed regulation. Start and stop ramps work in both mode. Speed adjust range, closed loop rpm range and ramps can be set with parameter. Analog input are filtered so that there can also use PWM signal for control speed and current.

Setting can be done digitally with EM-236 interface unit or with Emen-Tool lite program installed in PC and EM-328 adapter cable. Parameters stored into nonvolatile memory of device. This interface unit can also be monitored the current and rpm of motor.

Device can be installed in DIN-rail base and some enclosure options are also available.

TECHNICAL DATA

Supply voltage V_{cc} 12-24V (11-35Vdc)
 Overvoltage shut down 40V
 Undervoltage shutdown 10.5V, start up 11V
 Idle current typ. 30mA
 Max current 8A cont. (Tamb. 25 °C)
 Max current peak 12A (max 5s)
 Max brake output current 3A
 Brake res. min. 4.7ohm at 12V / 10ohm at 24V
 Pwm frequency typ. 16kHz
 Overtemperature Temp shut down 90 °C
 Current limit setting 0.1-12A (step 0.1A)
 Current limit analog scale 0-5V = 0-15A
 Logic level of digital inputs
 "off" = 0-1V or open / "on" = 4-30V
 Input impedance of logic inputs 10k
 Response time of digital input 2ms
 Analog input range 0-5V up to 0-10V
 Input impedance of analog inputs 100k
 Input filter of analog input 100Hz
 Fault output PNP max $V_{cc}/5V$ max. 50mA
 Fan output NPN max 100mA / activation temp. 55 °
 EMC measured for industrial env.
 PCB material flammability class UL94V-0
 Dimensions 65x73x22mm
 Weight 76g

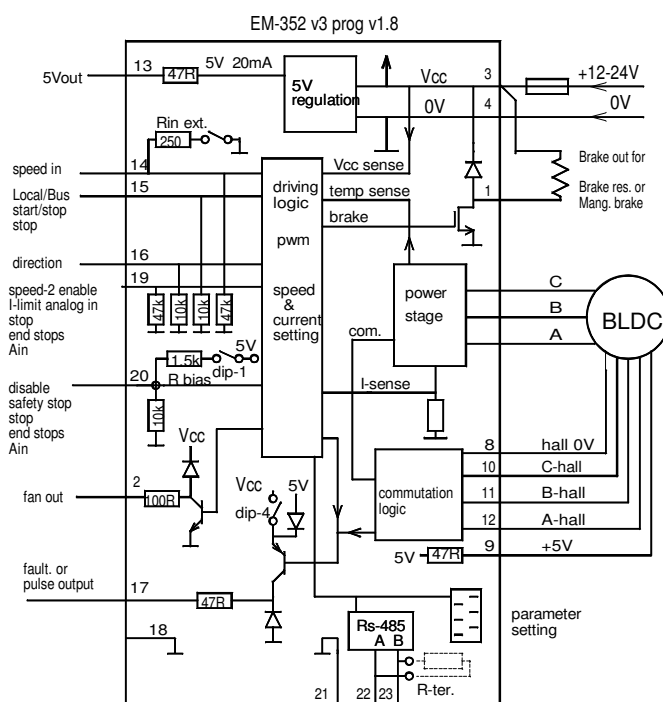

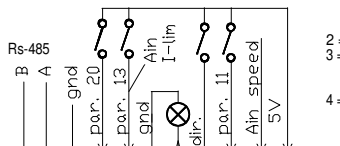
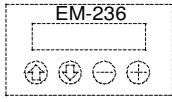

- 1 = connects 1.5k bias res. into disable input. See parameter 20 also
- 2 = not in use
- 3 = connects 250ohm resistor into speed input. this can be use with 0-20mA speed signal
- 4 = this connects 12V voltage to the fault output instead of 5V

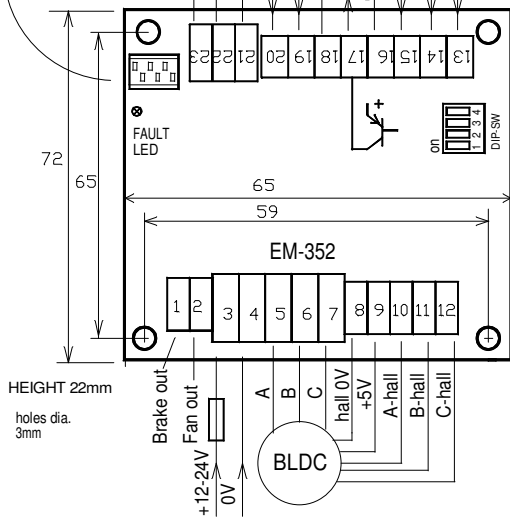

HEIGHT 22mm
holes dia. 3mm

SETTABLE PARAMETERS (prog. 352 prog. v1.9)

1. mode: open loop =0 / closed loop=1 / closed loop "slow" = 2 (0)
2. closed loop range 0-4 (3)
0=1500rpm, 1=750rpm, 2=500rpm 3=250rpm 4=150rpm
above ranges is for 4-pole motor (2 pole pair). For the motor with higher number of poles the max rpm is smaller in the ration of number of poles
3. start ramp 0-5s / 0-50 (10)
4. stop ramp 0-5s / 0-50 (5)
5. I-trip delay 0.01-2.5 / 0-255, 0=I-trip, disabled (200)
6. scale start speed 0-25.5% / 0-255 (0)
7. scale gain 0-2.55 / 0-255 (200)
8. Load compensation (Rxl) adjust 1-200 (5)
or in closed loop mode dynamic P-factor
9. closed loop dynamic I-factor 1-200 (10)
10. regen. braking current limit 2-12A / 20-120 (100)
11. Input PIN 15 options (0)
0 = open or "low" = Local / "high" = Bus
1 = open or "low" = Bus / "high" = Local
2 = local/Bus control selection with Bus only
3= local only and pin 15 as start/stop
4= local only and pin 15 as stop input
5= local only and pins 15 and 16 impulse input
6 = local only and pin 15 as end stop BW
12. current limit 0 / 1-15A / 10-150 (80)
13. Input PIN 19 options 0-100 / 0-100 (50)
0= input is I-lim analog input 0-5V
1= stop input
2= end stop FW
3 = end stop BW
4 = analog input
10-100 = speed-2 enable and par. = speed-2
14. I-trip reset mode (0)
0= only with disable pin
1= disable or with speed input change 0 to up
10-200 = timer reset with 0.1s steps = 1-20s.
- 15 Start up mode when power on & over temp. reset options (1)
0= ready to run when power on & over temp. reset disable input
1 = ready to run when power on & over temp. res. with speed 0 to up
2 = disabled when power on & over temp. res. with speed 0 to up
10-200 = ready to run when power on & over temp. reset with timer reset time 0.1s steps = 1-20s.
- 16 PIN 17 output function (1)
0 = overtemp. and overvoltage
1 = overtemp, overvoltage, and I-trip
2 = overtemp, overvoltage, I-trip and overcurrent
3 = reserved for pulse output use, see param 17
4 = same as the LED on circuit board
- 17 pulse output divider 1-20, enabled only if param. 16=3 (1)
1 = 1pulse/round
2 = 1pulse/ 2round...
...
20= 1pulse/ 20round
18. brake res. threshold (=overvoltage) 15-40V / 15-40 (35)
19. brake output mode and braking mode 0-3 (0)
0 = output active if param. 18 value exceed and brk. mode "regenerative"
1 = not in use
2 = output active when "run" and braking mode "regenerative"
3= not in use
20. Input pin 20 options (0)
0 = disable (and reset)
1 = safety switch stop with wiring monitor (closing contact)
2 = stop input
3 = end stop FW
4 = end stop BW
5 = Analog input
6= inverted disable (disabled when "low")
21. Baud rate 0..5 (3)
0= 9600, even, 1 stop, 3= 19200, even, 1 stop
1= 9600, odd, 1 stop 4= 19200, odd, 1 stop
2= 9600, none, 2 stop 5= 19200, none, 2 stop
22. Modbus Address 1...247 (1)

TAKE IN USE

Nominal operating voltage 12-35Vdc ripple less than 20%
An external supply fuse is recommended (2-15A)

Be sharp when connect motor wires, because there is lot of combinations. If motor takes much current or run roughly then change order of hall-sensor and try again

Default settings are in brackets in parameter list. These are good start-up values

When power turn on the device can be ready to run or disabled In ready to run mode driver starts directly if speed is set . In disable mode speed must be set to 0 before start is possible. See parameter 15

In example picture beside there all input connected, but device work also with less wiring, you can start only with speed signal (par. = 0). More wiring option on application sheet.

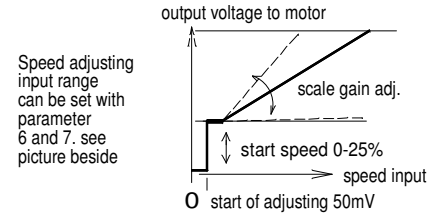

In some application load can be generated energy back to drive, when slowing down speed. Then there needed braking resistor, which absorbed extra energy. NOTICE that the parameter 18 has to be set about 10% higher than unloaded voltage of power supply. In the battery powered application the resistor not need, because the battery absorb the regenerated energy.

CONTROL INPUTS

SPEED input is a analog control input for speed setting. Set signal can be between 0-5V and 0-10V
Speed scaling can be made with parameter 6 and 7.

PIN 15 can be used to select control source LOCAL / BUS
Local control with card terminal or Buscontrol with Rs-485
This Input has also another options which can be set with parameter 11

DIRECTION input is a digital input. It changes the rotation direction. It uses automatically stop/start ramps during change.

INPUT PIN 19 is a multifunction input it can be set with 13. This can be worked as analog CURRENT LIMIT input, SPEED-2 activation input or different type of STOP inputs

INPUT PIN 20 is a multifunction input, it can be set with par. 20 This input can be worked as SAFETY SWITCH input, DISABLE input or different type of STOP inputs

SAFETY SWITCH option including also line monitor for safety switch. If the line resistance is too high the device gives warning

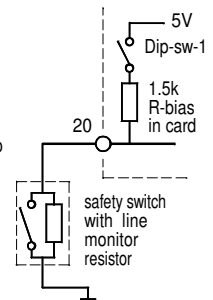

OUTPUTS

FAULT / PULSE OUT This output modes can be set with parameter 16. There is some options when output will be activate. The special mode is pulse output, in this case output gives out rpm-pulses which can scaled with parameter 17

BRAKE output can used to control magnetic brake of motor or switch a braking resistor in regenerative braking. the mode can be set with parameter 19
Recommend brake resistor , Wirewound 5-20W
Resistance 4.7R at 12V, 10R at 24V

Rs-485 port can be used to control device with Modbus protocol
This port has own guide sheet " Modbus register definitions for EM-356A"

MONITOR VALUES

1. current 0.1A / digit
2. braking current 0.1A / digit
3. hall sensor freq. 0-255Hz
4. operation voltage 0.1V / digit
5. pwm 0-255 (255 = 100%)

INDICATIONS.

Continuous light: Over. temp. or over voltage or disable
Fast blinking : current limit exceeded
Short blinks: shutted down by overcurrent (I-trip)
Long blinks: safety switch wire fault
Slow blinking: shutted down by safety switch

Fault output: (Pin-17 PNP open collector output)
Overtemperature, Overvoltage, Undervoltage.
This indicates also I-Trip if parameter 16 is set to = 0