

EM-366A-SBL BLDC DC-MOTOR DRIVER 12-48V 30/25A POSITIONING SERVO and MODBUS CONTROL OPTION

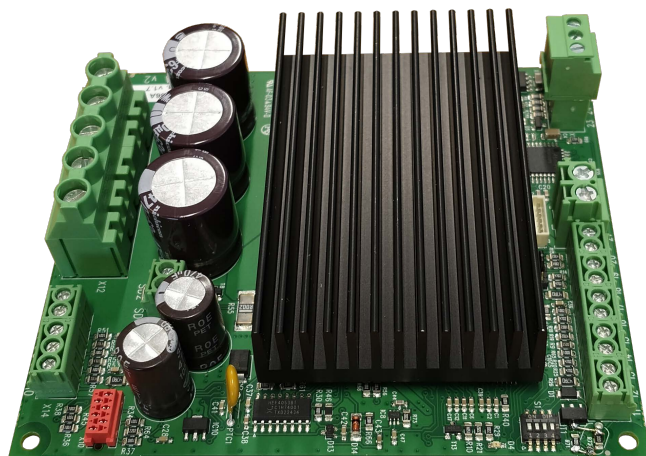

FEATURES

- For motor with hall sensor
- Max. motor recom. 200W@12V, 400W@48V
- Speed and torque adjustment
- Analog or Rs-485 Modbus control
- Servo amplifier for positioning
- Regenerative braking option
- Position counter 31bit
- True 4Q-power stage
- Braking resistor output
- Fan control output
- Current limit and trip
- Low EMC emissions
- DIN-rail mountable
- Firmware versions
 - v1.8 improved position counter freq.
 - v1.8 improved current limit features
 - v1.8 added param 19 "start level"
 - v2.2 added new homing options to par 15 and 16
 - v2.4 added option 3 to parameter 15
- Hardware version -A
 - shutdown input added
 - lower height than earlier

GENERAL

EM-366A-SBL is brushless DC-motor driver with hall sensor feedback. The unit has a mosfet power stage with good efficiency and it meets also today's EMC requirements. The driver can be used with 120° commutation. This driver has true 4Q power stage, and it makes possible to use regenerative braking. In this braking method the supply voltage rises, this voltage rising can be controlled with braking resistor. If uses battery supply then the braking energy can be leaded back to battery and braking resistor will not be needed. The unit has the basic digital command inputs like reset/homing, disable, local/bus and safety stop. There is analog input for position set. EM-366A-SBL has PNP output for fault indication use. Some input and output ports and functions can be set and change with parameters. Alternatively this driver can be also controlled via Rs-485 control bus with Modbus protocol. Driver includes overvoltage, undervoltage and overtemperature protections. These fault situations are indicated with fault on-board LED. Current limit situations can be reset with reset input, reset-timer or by setting analog speed control to value to 0.

This version of EM-366 uses motor feedback pulses also for positioning, little like in servo system. The positioning resolution depends on the numbers of motor poles. for example 1-pole-pair motor 6-position in round and 7-pole-pair motor 42 position in round. and this round means motor shaft rounds, so with gearbox the resolution can be improved. Driver has own positioning amplifier and with this can be easily adjusted dynamic and accuracy of system. Driver has also RS-485 bus with Modbus control protocol, this make flexible use and control many driver in system.

Setting can be done digitally with EM-236 interface unit or with Emen-Tool lite program installed in PC and EM-328 adapter cable. Parameters stored into nonvolatile memory of device. This interface unit can also be monitored the current and rpm of motor. Parameter setting and monitoring can be also done via Rs-485 bus.

Device can be installed in DIN-rail base and some enclosure options are also available.

TECHNICAL DATA

Supply voltage 12-48Vdc (11-58Vdc)
 Overvoltage shutdown 60V
 Undervoltage shutdown 10V
 Idle current typ. 30mA
 Max current 30A cont. (@ 24Vdc, Tamb. 40 °C)
 Max. current 25A cont. (@ 48Vdc, Tamb. 40 °C)
 Max current peak 60A (max 2s)
 Max brake output current 10A
 Pwm frequency typ. 16kHz
 Overtemperature Temp shut down 90 °C
 Fan activation temp 55 °C
 Current limit setting 1-60A (step 1A)
 Current limit analog scale 0-5V = 0-60A
 Logic level of digital inputs
 "off" = 0-1V or open / "on" = 4-30V
 Input impedance of logic inputs 10k
 Response time of digital input 2ms
 Analog input range 0-5V up to 0-10V
 Analog input resolution 10bit. (1024 step)
 Position counter resolution 31b (2147 milj. steps)
 Input impedance of analog inputs 100k
 Input filter of analog input 100Hz
 Hall input max freq. 800Hz
 Fault outputs PNP 5/12V max. 50mA
 Fan output NPN max. 100mA
 EMC measured for industrial and env.
 PCB material flammability class UL94V-0
 Dimensions 108x91x30mm
 Weight 230g

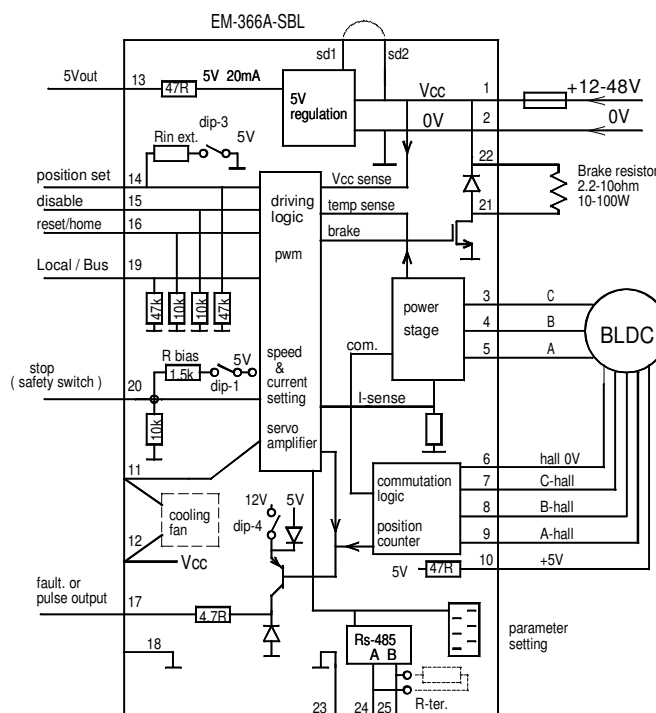

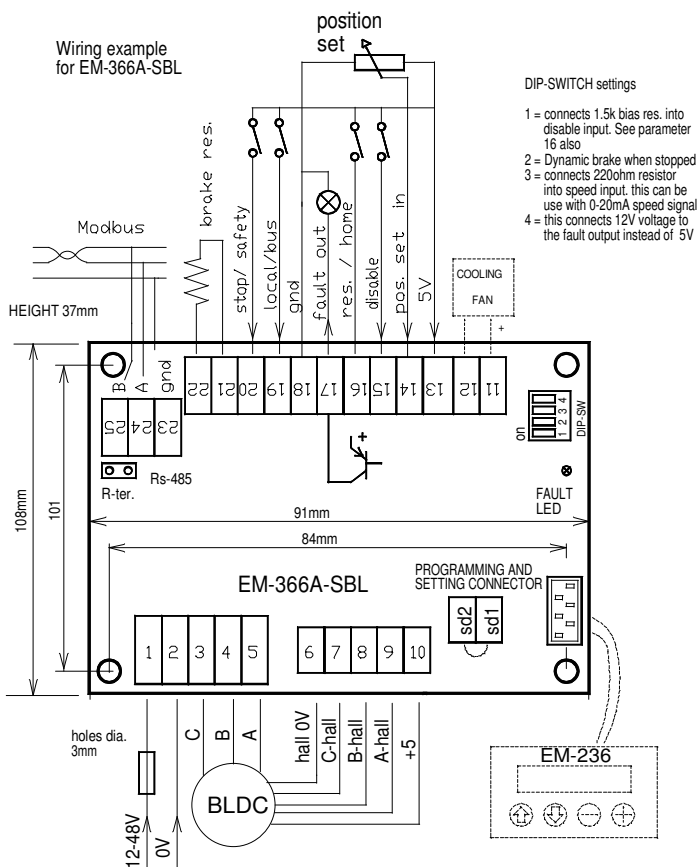

ADJUSTMENT AND SETTINGS

Settings can be done with three interface device options.

1. EM-236 interface unit
2. EM-328 series interface units with EmenTool Lite PC-software

SETTABLE PARAMETERS (prog. 366-SBL v2.4)

EM-366A-SBL parameters set with interface unit EM-236A or with Ementool-Lite and EM-328

1. Output voltage max. 0-60V / 0-60 (0)
values 0-9 = not in use
2. Overvoltage limit 15-60V / 15-60 (60)
Don't set this over max. supp. voltage
3. Start ramp 0-5s / 0-50 (10)
4. Stop ramp 0-5s / 0-50 (2)
5. I-trip delay 0.01-2.55s / 0-255 0=no trip (50)
6. Current limit FW 1-60A / 1-60 (5)
7. Current limit BW 1-60A / 1-60 (5)
8. Load compensation 0-255 (0)
9. Max. speed FW 0-100% (100)
10. Max. speed BW 0-100% (100)
11. Home speed 0-100 (50)
12. Reset option 0-1 (1)
0 = only with reset input,
1 = also with opposite direction
13. brake output mode and braking mode 0-3 (0)
0 = overvoltage activates output and brk. mode is "regenerative"
1 = overvoltage activates output and brk. mode is "freewheel"
2 = output active when "run" and braking mode is "regenerative"
3 = output active when "run" and braking mode is "freewheel"
14. Fault output options (pin 17) (0)
0 = over temp, I-trip.
1 = over temp, overvoltage and I-trip
2 = over temp, overvoltage, I-trip and overcurrent
3 = continuous light when "positioned" and blinking if fault
4 = fault output same function as on board ind. led
15. Res/home input config. (pin 16) (2)
0= 5s. command starts homing.
1= 5s. command starts learning
2= 5s. command starts homing, and new short command during homing stop and reset position counter
3= short command to res/home input reset position counter this can be used only if par 18 = 0, 3 or 5
16. stop/safety input config. (pin 20) (2)
0= digital stop input
1= safety switch input with line monitor
2= digital stop input, and stop homing and reset position
17. Positioning counting direction 0 or 1 (0)
18. Control options and Local / Bus selection (3)
0= fw-bw switch mode, pin 19 select Local mode
1= fw-bw switch mode, automatic return to bus with 1s delay
2= fw-bw switch mode, Return to Bus control with Bus command.
3= Analog in mode, pin 19 select Local mode
4= Analog in mode, Pin 14 voltage changes activates local cont. Return to Bus control with Bus command.
5= Back up switch mode, pin 19 select Local mode
6= Back up switch mode, automatic return to bus, with 1s delay
7= Bus control only
8= Bus control only and disabled at power up
19. start level 10-50 (20)
20. Baud rate 0...5 (3)
0= 9600, even, 1 stop
1= 9600, odd, 1 stop
2= 9600, none, 2 stop
3= 19200, even, 1 stop
4= 19200, odd, 1 stop
5= 19200, none, 2 stop
21. Modbus Address 1...247 (1)
22. Input range min. Ain 0-10V / 0-1000 (0)
23. Input range max. Ain 0-10V / 0-1000 (1000)
24. Bw end limit 0-10000 pulse from home / 0-10000 (0)
25. Fw end limit 0-10000 pulses from max. of range / 0-10000 (0)
26. Braking area 1-1023 pulses / 1-1023 (200)
27. Dead zone 2-100 pulses / 2-100 (25)
28. Range at pulses 0-65535 (5000)
29. Range factor 1=65535 / 0-32767 pulses (0)

CONNECTION ADVICE

Recommended supply voltage range is 12-48Vdc.

Ripple should be lower than 30% even with max. load.

NOTICES !

1. Wrong supply polarity can cause damage the device.
2. There is no inbuilt fuse in this device. Use an external fuse which is chosen according to your application.
3. that function and scale of some of the input and output terminals is depending on the selected parameter values and defined ranges.
Please, see the parameter list and explanations.
4. BLCD the right connecting is important, motor manufactures can be different marking method.
If motor takes lot of current or not at all, the try to change the order of hall- sensors (a, b, c)
5. If you start using with local control, then parameter 18=3 and link pin 19 to pin 13

CONTROL INPUTS AND OUTPUTS.

POSITION SET (Analog input)

This is analog input. for local mode position setting. This input range is basically 0-10V. But the input range can be adjusted with parameters 20 and 21 see more ANALOG INPUT RANGE section.

DISABLE

This terminal is PNP input, positive command disables device. This input has highest priority.

RES/ HOME /LEARN

At short command this input reset fault, and with longer 5s command this input starts HOME or LEARN routine. Input configured with parameter 15.

LOCAL / BUS (control select)

This input is normally for selecting several LOCAL or BUS control modes, this input can be config. with parameter 17 When input pin is open, then local mode is selected.

Rs-485 (modbus)

Standard half-duplex Rs-485 terminal incl. gnd, A and B The line terminal resistor 120R can be set to socket R-ter if needed.

BRAKE OUT

This NPN output can be used to control magnetic brake of motor or as a braking resistor in re-generation situation see. parameter 13

MONITOR VALUES

1. current 1A / digit
2. pwm 0-255
3. position 0-65535 pulses
4. position factor 1=65535 pulses
5. operation voltage 0.1V digit

INDICATIONS.

Continuous light: Over. temp. or over voltage or disable
Fast blinking : current limit exceeded
Short blinks: shutted down by overcurrent (I-trip)
Long blinks: safety switch line fault
Slow blinking: shutted down by pin safety/stop (pin 20)

Fault output: (Pin-17 PNP open collector output)
This indication output is configured with param. 14

TAKING IN TO USE

The setting of the controller is done with parameters, and the parameters can be set and edited with Interface devices EM-236 or EM328 Unit. In the beginning set the two first parameters according to the application. Check also that current limit parameter are suitable for your application.

OVERVOLTAGE (brake output threshold)

Set parameter 2 at least 10% higher as voltage of supply. If supply voltage rises over overvoltage limit (set with param. 2) then the brake output pin 21 activates. and if brake resistor is connected then it will absorb braking energy. If supply voltage rises 3V over overvoltage limit, then driver will be disabled.

POSITION FEEDBACK (feedback pulse inputs)

This driver uses hall-sensor of motor also for positioning. For example 1-pole-pair motor gives 6-position/round, and 7-pole motor give 7 times more 42-position/round.

FULL RANGE

Full range is the full mechanical movement of the linear or positioning system. At first it is always needed to determine the full range before it is possible to drive the system correctly. The full range can be determined with LEARN routine or if this is already known it can be set directly to parameter 28 and 29 (Full range). The position counter is 31bit and that's why the parameter has split to "ones" and " 16bit factor"

HOMING (position counter reset)

The position feedback is received as pulses so the driver can not know the absolute position before pulse counter is reset in some known position. During the homing the motor run to BW direction, this run can be stopped with I-trip (current limit shutdown) or with RUN/HOME or STOP/SAFETY inputs. This way stopped homing run reset the position counter.

LEARNING (absolute position match and measuring of full range)

Learning is an extended routine of homing. It is for finding the full range for system and also match the absolute position. Homing or learning is selected with parameter 15

home pos. "HOMING" cycles 1 to 3 position full
counter "LEARNING" cycles 1 to 6 range
= 0

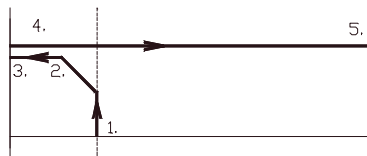

1. start homing or learning by giving a long 5s command to RES/ HOME/ LEARN input (pin 16)
Notice, that parameter 15 should be 1 to enable learn
2. motor starts to run "home" direction with home speed
Home direction is same as "bw" direction
3. current limit stops the motor when the end is reached and position counter will be reset.
This is also the end of HOMING cycle
4. motor starts to "fw" direction and makes a full stroke.
During stroke the pulse counter measures the range.
5. motor reaches the mechanical end of fw direction and current limit stops the motor.
6. Device stores full range value and it is ready for use
7. After successfully learning we recommended to return parameter 15 to value 0 (home)

NOTICE that above the homing cycle is finished with I-trip (= overcurrent shutdown) But it is also possible to stop the homing with new command with HOME/RES input or with command with STOP/SAFETY input. see parameter 15 and 16, options 2

TROUBLES ON HOMING OR LEARNING

Motor will not run at all in homing or learning.

- hall pulses has wrong phasing, try to change to hall sensor wiring
- system is stuck
- current limit is too low for system

Motor run only about 0.5 sec, and ind. led blinking

- counting direction is wrong, change parameter 17

LOCAL / BUS (control mode select)

This driver can be used with local control inputs or with Rs-485 Bus. The Bus control offer more options than local input and for bus control has own instructions. "Modbus register definitions for EM-366-SBL". Device is set for bus mode as a default. (see param. 18) If you want to start with Local control, then set pin 19 "on"

CONTROL OPTIONS

Device has several control option. The main select is Local or Bus control. As a default device is in Bus control mode, The Bus is Rs-485 Modbus RTU. and it has separate instructions "Modbus register definitions for EM-366-SBL".

The parameter 18 defines how the device can change to Local control mode, which means that control inputs of card is enabled. Local mode with fw-bw switch can be set pin 19 "on", or direct with fw-bw switch. Return to Bus control with pin 19 "off", or automatically or with Bus command. Local mode with potentiometer can be activated with with pin 19 or with 5% voltage change of potentiometer. Return to bus mode with pin 19 to "off" or with Bus command. In the back up switch mode the switch has high priority and it bypass positioning servo and end limit.

Below two basic wiring for Local control

FW-BW SWITCH MODE

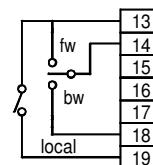

ANALOG IN MODE

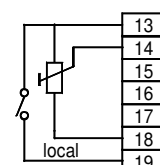

START LEVEL (motor min. speed)

With parameter 19 can be set the starting voltage of motor, this and load compensation parameter 8 defines how the motor works near a target position, we recommend to set this parameter first and then param. 8.

LOAD COMPENSATION (torque at low speed)

Load compensation (par.8) when set to right value, will ensure the needed force to start driving and to taking the load in to the right position. With high load and too low load compensation value, the motor don't have force enough to reach the right position. Start testing with zero value and increase value until motor behaves unstable and twitching. Thumb rule in this point is to decrease the value with 25%.

CURRENT LIMIT and I-TRIP (torque limit and shutdown)

Current limits should be set according to the motor nominal max. current or according to the required current of the application. these set with parameter 6 and 7
Current I-trip (overcurrent shutdown) delay can be adjusted with parameter 5. Notice if this parameter is set = 0 then shutdown is disabled but current limit still works

INDICATIONS

Fault situations are indicated with coded blinking of the red LED. and fault code number is also read from monitor value.

Fault output (pin.17). indicated fault situations also. This output pull up in fault situation as, overtemp, I-trip, pulse lost etc. see parameter 14

RESETTING OF FAULTS

The faults can reset with short command with RES./ HOME / LEARN input. I-trip and pulse lost faults reset also automatically if gives new position set which starts run to opposite direction. Faults can be reset also via bus, if bus mode is selected.

ANALOG INPUT RANGE ADJUST

This driver analog position set input is 10b (1023 step), and with analog input cannot reach same accuracy as with bus control.
The input range is 0-10V, but this range can be compressed with parameter 22 and 23. for example. Input signal is 0.4 - 5.0V, then set parameter 22 = 40 and 23 = 500.
This input can work also as 0-4-20mA input, dip-switch 3 can be connected 220ohm input resistor, then parameter values are correspondingly 22= 88 and 23= 440

Example of RANGE LIMITING

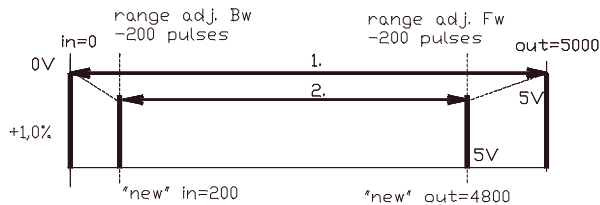

1. Original learnt range = mechanical full range
Is in this example = 1000 count.
Control signal is 0-5.0V (param. 22=0 and 23=500)
2. Desired mechanical range compression
bw end limit = set parameter 24 = 200
fw end limit = set parameter 25 = 200
"New" stroke of actuator is compressed to:
positioning set value 0V = 200
positioning set value 5V = 4800

POSITIONING DYNAMIC

Dead zone (par.27) is to determine the accuracy of positioning. This parameter has the major effect to positioning accuracy. The smaller value means theoretically better accuracy, but on the other hand too small value affect unstability in positioning. The right value will be find with testing, Notice! that mechanical slack and stiffness could be reason to increase dead zone.

Braking area (par. 26) is used to optimize the time needed for positioning. Too high value slows down too early, and too low value will cause an fast position passing and needs a corrective return driving.

Start and stop ramp (par. 3& 4) are to smoothen the direction change. Often suitable value for stop ramp is half of start ramp. Too long stop ramp can make the direction change too time consuming and too short can cause mechanical stress and non desired aggressivity.

POSITIONING WINDOW

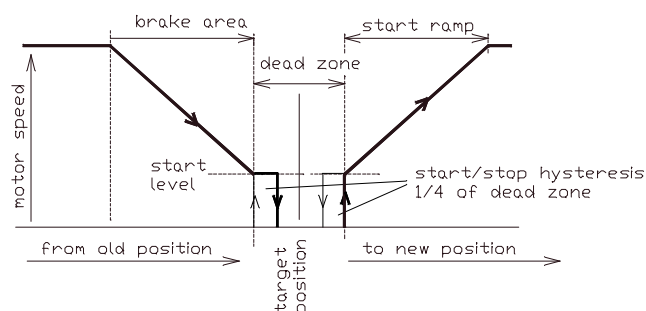

SAFETY SWITCH INPUT (stop input with monitoring)

The stop input can be used as safety switch input with monitor. Safety switch has usually monitoring resistor, which has used to monitoring the condition of safety switch wires. This input has possibility to monitoring this line when "safety switch" option has selected with parameter 16 . R-bias enabled with dip-sw 1 Recommended safety switch resistor 1-2.2kohm
If line fault detected, then the device gives "line fault" warning
The acceptable voltage value is between 1.6...3.5V
This input is enabled also in BUS control mode.

