

# EM-339A-48V-SPF POSITIONING DRIVER FOR TWO PARALLEL DC-MOTOR 24/48Vdc 2x8A or 2x15Apeak, Rs-485

## FEATURES

339As481 6.02.2021

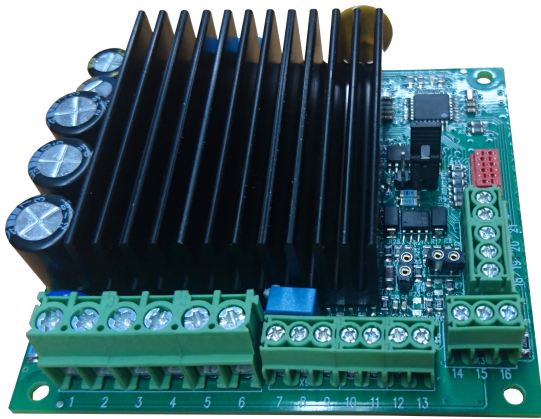

- synchronized parallel driving
- operates with pulse feedback
- input for negative or positive pulses
- current and temperature limit
- settable drive speed
- speed regulation
- 2 or 16kHz pwm frequency
- acceleration and deceleration ramps
- analog input for position control
- parameters for stroke length adjust
- easy setting with serial interface
- brake ( release ) output
- quadrature pulse counting
- emerg. switch input
- safety reverse function
- low emissions, EMC tested
- Modbus control port
- EM-339A is recommended as a substitute for EM-239 in new application
- EM-339A version pcb has added Rs-485

EM-339A-48V-spf is designed for driving two actuators in parallel. The drive is done as synchronized according actuators pulse feedback signal. The synchronization is achieved by adjusting actuator speed during drive. If the adjustment can not compensate the unbalance between actuators, the motors will be stopped. This way the mechanical stress and breakage can be avoided. Additively the driver includes current limit and power stage temperature limit. Driver works with actuators that can offer pulse feedback signal. Pulses can be derived from Hall-sensors, reed or other kind of switches which generate 0 and 90° pulse chains. Driver can be set to read negative or positive pulses. Driver power stage operates with PWM (pulse width modulation), that enables the high efficiency and low losses of power stage.

This -SPF firmware version uses a analog SET signal, then driver works like servo driver and positioning actuators to the same value as the set value. The range of set value can be adjust with parameters. Driver has also support for SAFETY-SWITCH with line monitoring, and also with parameter can be set SAFETY REVERSE reversing time. This device is designed work also with Rs-485 Modbus. With Modbus can be controlled, set parameter and monitored device. For Modbus use has separated instructions.

The parameters are set with a handy interface unit EM-236. There is also possibility to use EmenTool Lite PC-software with EM-268 and EmenTool App with smartphones for parameter setting.

## TECHNICAL DATA

Supply voltage nom. 20-58 Vdc ( nom. 24-48Vdc)  
 Undervoltage shutdown 8V, restart 10V  
 Quiescent current 15mA  
 Motor output currents  
 2 x 8A cont. or 2 x 15A ( at 25% duty and 2kHz)  
 2 x 5A cont. or 2 x 10A ( at 25% duty and 16kHz)  
 PWM frequency 2kHz/ 16kHz  
 Current limit 1-25A  
 Temp. limit 120°C ( pow.stage )  
 Ramp times 0 - 2s  
 Pulse input freq. max. 700Hz/ input ch  
 Pulse inputs pull- up/down 10kohm.  
 Control inputs 0-1V = OFF / 4-30V = ON  
 Input impedances 47kohm.  
 Analog control input 0-5V, 0-10V or 4...20mA  
 Input impedance 10kohm (or 250ohm at 4...20mA)  
 Fault-output, pull down max. 100mA  
 Brake-output, pull down max. 2A  
 Aux. voltage output 5V, max. 20mA  
 Bus, Rs-485 half duplex, 9600 or 19200 bps  
 Dimensions 78 x 73 x 25mm  
 Operating temp. range -20 to 60°C  
 Weight of card 110g  
 CE Electromagnetic compatibility  
 EN-55022B and EN 61000-6-2/ -4-2...6

EM-339A-48V-SPF BLOCK DIAGRAM

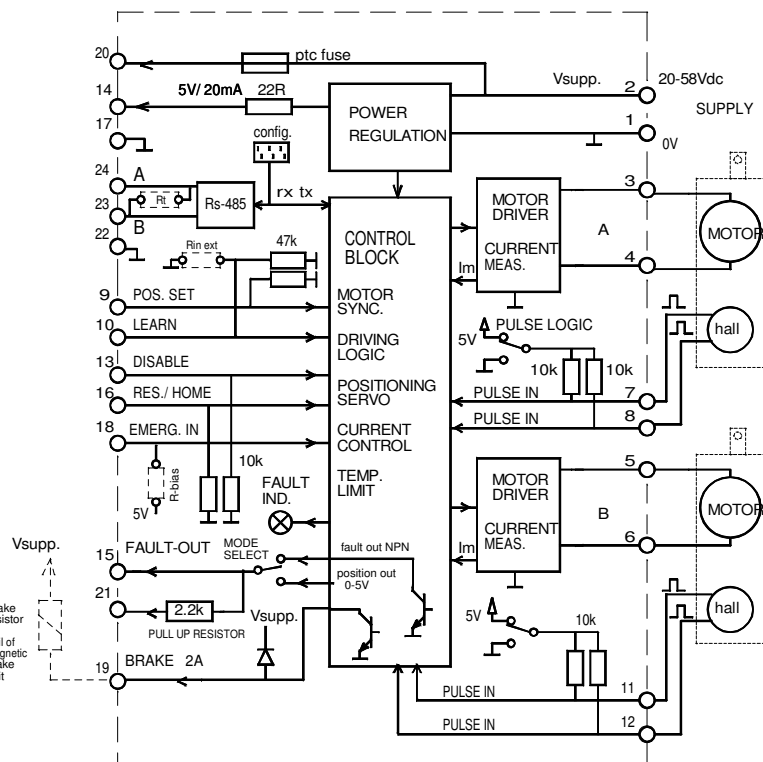

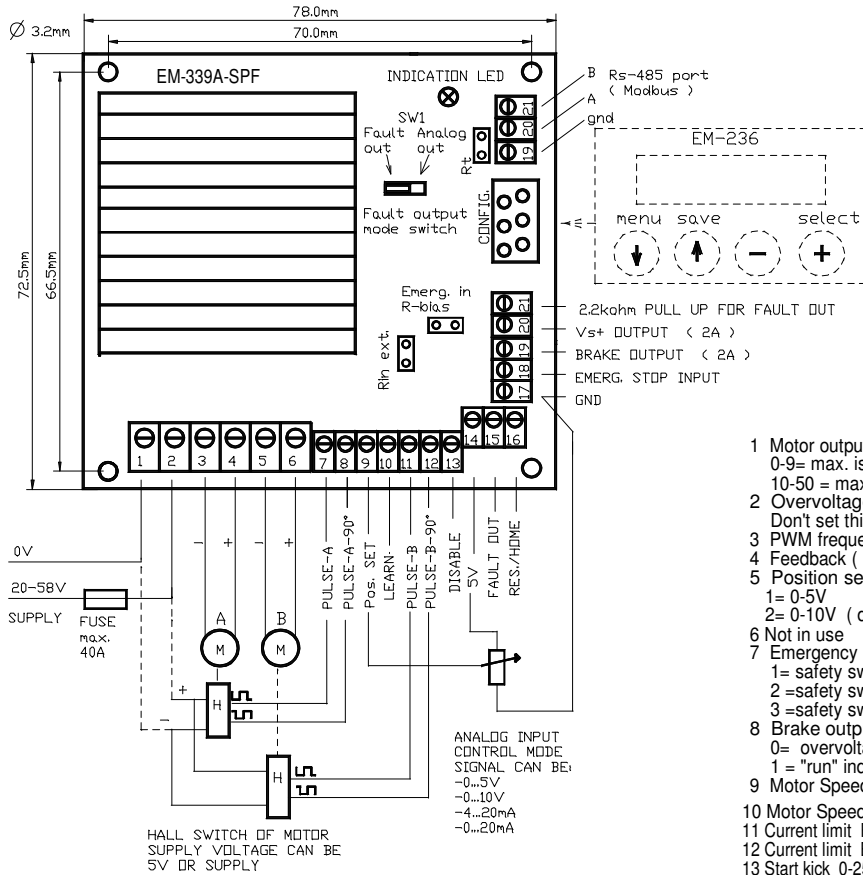

PARAMETER SETTING AND MONITORING

The parameter adjusting can be done with next EM- interface devices  
 -EM-236 is basic stand alone setting device.  
 -EM- 328 USB-serial converters, which makes it possible to set parameters also with computer where is installed EmenTool Lite  
 -EM-326 is Bluetooth -dongle which can be used in smart devices with the EmenTool App.

PARAMETER LIST EM-339A-spf v1.1 (default in brackets)

- 1 Motor output max. voltage 10-50V / 0-50 ( 0 )  
0-9= max. is same as supply voltage  
10-50 = max voltage = parameter value
- 2 Overvoltage 15-60V / 15-60 ( 55 )  
Don't set this higher than supply max. 35V
- 3 PWM frequency 1=2kHz, 2=16kHz ( 1 )
- 4 Feedback ( Hall ) pulse logic 1=PNP, 2=NPN ( 2 )
- 5 Position set input max. range ( 1 )  
1= 0-5V  
2= 0-10V ( doubles param. 23 and 24 voltage values )
- 6 Not in use
- 7 Emergency stop input options ( pin 18 ) ( 2 )  
1= safety switch input with opening contact ( N.C. )  
2 =safety switch input with closing contact ( N.O. )  
3=safety switch with ( N.O. ) and with line monitoring
- 8 Brake output activation ( pin 19 ) ( 0 )  
0= overvoltage ( exceeding param. 2 value )  
1 = "run" indication
- 9 Motor Speed 20-100% / 20-100 ( 100 )
- 10 Motor Speed-2 20-100%/ 20-100 ( 60 )
- 11 Current limit FW 0.1-25A / 1-250 ( 50 )
- 12 Current limit BW 0.1-25A / 1-250 ( 50 )
- 13 Start kick 0-250 ( 1 )  
0=start kick disabled  
1= start kick after homing ( 100ms )  
2 to 250 = start also after I-trip and the param. value defines start kick time as milliseconds
- 14 Fault output ( pin15 ) modes 1-6 ( see also switch SW1 ) ( 1 )  
1= output activates (= pull down ) if fault detected  
2= output shifting on/off, if homing or learning faults  
3= output shifting on/off in phase with indication led  
4= output activates when position is "positioned"  
5= analog position output 0-5V  
6= analog pos. output 0.5-4.5V and fault =0V
- 15 Start ramp 0-2.5s/ 0-25 ( 10 )
- 16 Stop ramp 0-1s / 0-10 ( 2 )
- 17 Pulse lost reaction time 0-1s / 0-100 ( 50 )
- 18 Safety reverse option 1-10s + dir. / 0-30 ( 0 )  
0= disabled  
1-10 = reversing time 1-10s. both dir.  
11-20 = reversing time 1-10s. only REV. dir  
21-30 = reversing time 1-10s only FW dir.
- 19 Load compensation 0-255 / 0-255 ( 0 )
- 20 Synchronisation strength 1-50 / 1-50 ( 10 )
- 21 Braking area 1-8% / 1-8 ( 4 )
- 22 Dead zone 0.1-5% / 1-50 ( 10 )
- 23 Set input min 0-5.50V / 0-551 ( 0 )
- 24 Set input max. 0-5.50V / 0-551 ( 550 )  
above parameter 551 is a auto setting mode
- 25 Range limit BW direction 0-50% / 0-500 ( 5 )
- 26 Range limit FW direction 0-50% / 0-500 ( 5 )
- 27 Full range 0-65000 pulses / 0-65000 ( 1000 )
- 28 Serial line configuration, speed, parity, and number of stop bits ( 1 )  
1 =9600bps 8N1 5 =19200bps 8N1  
2 =9600bps 8N2 6 =19200bps 8N2  
3 =9600bps 8E1 7 =19200bps 8E1  
4 =9600bps 8O1 8 =19200bps 8O1
- 29 Modbus address 1-247 ( 1 )

TERMINALS

PULSE SENSOR INPUTS can be set to work in NPN ( pull to gnd ) or PNP ( pull to positive ) mode, Mode are set with parameter 4 The hall switches of motors can be supplied with supply voltage or with 5V from card. Check right voltage from motor datasheet.

IMPORTANT.

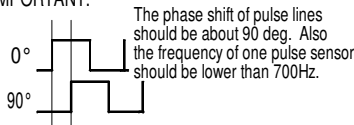

POSITION SET input is analog input 0-5V or 0-10V. This can be work also as 4...20mA input, This need 250ohm ( 249ohm) resistor to install into Rin-ext socket into board.

LEARN input is PNP input and start learn routine.

DISABLE input is PNP input. Disable in stops operating, this input has highest priority. The operation is disabled as long as this input is active.

EMERGENCY STOP INPUT pin 18 is basically PNP input, but it can be work as wiring condition monitor input, in this mode it works as biased analog input. Monitor mode need in safety switch which has inbuilt resistor for wiring monitor. This input can be set with parameter 7 and monitor bias resistor can be installed in R-bias socket.

Wiring and R-bias value examples for safety switch on chapter EMERGENCY INPUT OPTIONS on page 4 RES. / HOME input is PNP input. Short command reset faults and long command ( >5s ) starts home routine

RES. / HOME input is PNP input. Short command resets fault, long command ( >5s ) starts home routine. See page 3 for more info.

FAULT OUTPUT is a normally open NPN output, This can be used also as PNP output with connecting internal pull up resistor. ( link pins 20 and 21 ) This output mode can be set with parameter 14 See also switch SW1 when set parameter 14

BRAKE OUTPUT is NPN 2A output for releasing magnetic brakes for motors or alternatively for switching brake resistor in overvoltage situation. This output can be set with parameter 8

Rs-485 port  
This halfduplex serial port, device can be work as Modbus RTU. Bus control has own instructions.

MONITORABLE VALUES

- 1 fault code, as indication led blink count
- 2 motor A current - 0.1A/digit
- 3 motor B current - 0.1A/digit
- 4 current limit actual set
- 5 motor A pulse counter
- 6 motor B pulse counter
- 7 feedback position 0-1023
- 8 set position 0-1023
- 9 operating voltagen 0.075V / digit
- 10 safety mon. input 0.05V/digit

INDICATION LED ( number of blinks )

- Continuous = homing or learning in progress
- 1 blink = homing or learning failed / position corrupted
- 2 blinks = overcurrent
- 3 blinks = no pulses detected
- 4 blinks = motor position difference too big ( synchronisation error )
- 5 blinks = overvoltage
- 6 blinks = safety input wiring failure
- 7 blinks = Bus time-out

## CONNECTION

Connect motors and supply as in picture (page2). Supply voltage 20-58Vdc must be filtered. Ripple less than 20% . Device has no inbuilt fuse, so use external fuse, recommended value range 10-40A.

## START-UP

First when the device is turned on a parameter check should be made. Connect interface unit in to device and change parameters to suit the application, most important is to check: pulse logic, current limit and full range.

## HOMING CYCLE ( position counter reset )

At the start of use the pulse counters of device has to reset, and in some situation device might lose the position information, for example when it moved manually while the power is off. In above cases the position counter can be matched with homing routine. In the homing the motors run at speed-2.

## START THE HOMING CYCLE

The homing routine is activated with 5 second command for RES/HOME input. After starting motors run BW direction and ind. led turn on. NOTICE ! Keep command "on" until motor stops and led turn off . If one of the motor does not reached the end or led stay blinking, then start homing routine again so many time that both are reached the and indication led is turned off

## LEARNING CYCLE ( position counter range set )

The learning cycle idea is learn the right range for device with special running cycle. After completing the learning cycle successfully, the device has automatically set a mechanical operating range for itself NOTICE! learning is not necessary if already known the full range pulse count. then it can be set manually with full range parameter

## START THE LEARNING CYCLE

Learn routine starts with positive command for learn input ( pin 10 ) Motors start to run and led turn on. NOTICE ! - Keep command "on", until led turns off. If led stay blinking then try again drawing below shows how the learning should progress. NOTICE 2 - remove interface unit ( EM-236A or EM-328 ) during this learning process

Full Range = mechanical range end to end

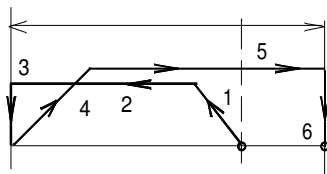

HOME makes steps 1 to 3  
LEARNING steps 1 to 6

1. Start to BW direction (led turn on)
2. Run to BW direction speed-2
3. BW end ( led turn off in homing )
4. Start to run FW direction
5. Run and count to FW direction with speed-2
6. Reach FW end, device set full range (led turn off)

## TROUBLE SHOOTING AT HOMING AND LEARNING ROUTINE

A: motor run only about second and indication led blinking  
- check parameter 4  
- check pulse sensor voltage  
- pulse sensor phasing is wrong = wrong counting direction  
swap the pulse wires or swap the motor wires

B: motor run not at all:  
-current limit is too low, check parameters 11 and 12  
-motor or system is mechanically stuck

C: The homing works, but into the wrong direction, then swap the motor wires and also swap the pulse sensor wires.

## SET RANGE ( position set input range)

The analog position set input is pin 9, This input can be set with parameters 5, 23 and 24. The max. range selected with param. 5 options is 0-5V or 0-10V. Parameter 23 and 24 is for fine tuning of range.

Example 1 control signal is 0.1-3V, then set param. 23 = 10 and param. 24 = 300.

Example 2: Control signal is 4...20mA, then plug in Rin-ext resistor 250ohm, this convert mA signal to voltage signal 1-5V, then set param. 23 = 100 and param. 24 = 500.

Example 3: Control signal is 0-10V, set param. 5=2 and 23=0 and 24 = 500. Notice the parameter 5 selection has doubled the voltage values of param.

## Example 4: Auto set

Adjust the control signal to the min. value, set param. 23 to value 551 and SAVE, card will save automatically adjusted value to the parameter value. Same time Adjust max. value to the input and set param. 24 to the value 551 and SAVE. Now the min. and max. NOTICE. after this procedure you have to remove interface unit and then connect it again, and read parameters (load & edit) and save parameters (save).

## RANGE LIMITATION

The learned range can be limited with param 25 and 26

1. Original learned range = mechanical full range = position counter normalized to 0 - 1023 in learning
2. Modified range example:  
BW limit = 20,0% and FW limit = 30,0%.  
Now the stroke of actuator is compressed so that position set min. to max. = 20% to 70% mech. range

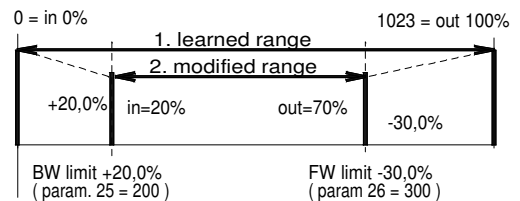

## FULL RANGE.

Full range parameter 27 can be set also with manually instead of learning routine. If you already known the full range of application, then you don't need to make learning. You can also manipulate the mechanical full range of system with adjusting full range parameter. Increasing of the value will expand the mechanical range and vice versa.

## POSITIONING COMPARATOR ( positioning behaviour )

Positioning accuracy and dynamic ( param. 19 and 20 ) Brake area is a slowing down slope when approaching the set point, faster application will need wider braking area. The dead zone is area where motor is "positioned" Narrow dead zone means better accuracy, but too narrow dead zone can be generated vibration.

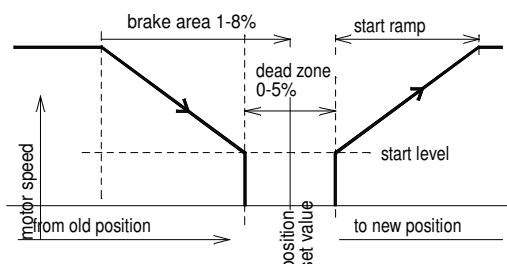

## START AND STOP RAMPS

ramps smooths start and speed changing. These are set with parameter 15 and 16

### CURRENT LIMIT (torque limit)

Both motor has own current limit measuring, if current of another motor exceeds the current limit, then both motor will shut down. Overcurrent shut down is disabled during start ramp, but the current limitation is always active and it protects against overtorque. Current can be set separately for FW and BW direction with parameter 11 and 12.

### PWM FREQUENCY

Driver has two option for pwm frequency 2 or 16kHz, with 2kHz power stage has lower losses and it can give more output current. But 2kHz can also generate whistling voice, this can be avoided with selecting 16kHz frequency.

### SPEED (without speed regulation = parameter 1=0)

Driver has two speed setting parameter 9 and 10. These param. determines the output voltage of the motors in relation to the supply voltage. for example 50% at 48Vdc supply voltage means 24V motor voltage. The speed-1 is normally in use. The speed-2 is enabled in homing and learning cycle.

### MOTOR OUTPUT MAX. VOLTAGE (speed regulating)

This function regulates motor speed so that changes of supply voltage will not affect the motor speed. This is enabled and adjusted with parameter 1. For example, if supply voltage varies 48-56V, then you can set this parameter to value 48V. which means that motor output 100% =48V. If this function is disabled ( param. 1=0 ) then 100% output is = supply voltage

### LOAD COMPENSATION (torque at low speed)

If the motor seems to be lack of torque at high load, specially at small position changing its endurance can be improved with compensation parameter 19. Increase slowly the parameter's value for example by 10 units and make loading test, repeat this until you get torque enough for low speed. However, setting a too high value will make the motor twitch.

### SYNCHRO STRENGTH

The parameter 20. defines how strong the synchronisation is between motor A and B. The bigger value means stronger synchronisation, which means that motors follow stronger to each other, but too big value could generate twitching.

### DIFFERENCE LIMIT (unsynchronous. shutdown)

If difference between motor increases more than 50 counts, then difference limit detection will shutdown motors. Recovery from this situation only with home or learning.

## SAFETY "REVERSE" FUNCTION

This function reversing motors automatically if system meets obstacle. With parameter 18 can be set the direction when function is enabled and also how long time motor reversing. This function trigs on from current limit or with command from emergency stop input. Notice! that emergency stop input start safety reverse only BW direction

### PULSE LOST REACTION TIME

Parameter 17 defines delay time for pulse lost shutdown. If some of motors don't give pulses then all motors stopped. Default value for reaction time is 0.5s

## EMERGENCY INPUT OPTIONS

This input is especially for external safety switch. Safety switch has usually monitoring resistor, which has used to monitoring the condition of safety switch wires. This input has possibility to monitoring this line when "safety switch" option has selected with parameter 7.

R-bias has own socket on board. R-bias is selected suitable with safety switch resistor. below few examples.

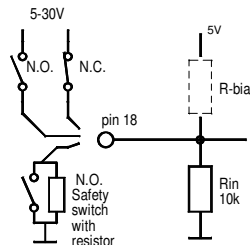

Examples for bias resistor  
switch res. 1k then R-bias 1k  
switch res. 2.2k then R-bias 1.8k  
switch res. 4.7k then R-bias 3.3k  
switch res. 10k then R-bias 4.7k

## FAULT RESETTING

Current limit and pulse lost errors will be reset with "new" opposite direction command or also with reset command to pin 16.

Homing failure and difference limit errors have to reset with new "homing" routine

Overtemp and overvoltage error will be reset automatically, when error situation disappear

## OVERVOLTAGE (brake output in overvoltage situation)

Brake output can be used to control so called brake resistor which work like shunt regulator and absorb the overvoltage. The resistor can be connected from supply to pin 19. In this use the param. 8 must be = 0 and the param. 2 defined the activation point of brake output.

If supply voltage exceed the set value of param. 2 then this output activates ( brake resistor activates ) If supply voltage despite of this still increases then the powerstage of the driver will set to freewheel.

NOTICE! don't set param. 2 higher than recom. supply voltage max.

## START KICK

This routine which can be given after homing or l-trip. It means motor starts short time with full power to release possible mechanical jamming. This is configured by parameter 13